









Luminaria Alumbrado Público LED **Monzon**



50-100-150W

Línea de alumbrado público LED de alto desempeño lumínico y diseños especiales para áreas de alto tráfico y exposición a las inclemencias del clima.

- 
Diversas distribuciones lumínicas
- 
Dimensiones reducidas
- 
Único color de cuerpo
- 
Compacto
- 
Montaje vertical
- 
Tecnología LED
- 
Bajo impacto ambiental
- 
Único color de luz

Vida útil
50.000Hrs

- SEC
- RoHS
- IP66
- CRI 70



Especificaciones técnicas

Temperatura de color 5.000°K
Ángulo de apertura T II Med
Material cuerpo Aluminio y policarbonato
Tipo de LED SMD 2835
Input 120-277 VAC
Eficacia >110lm/W
Fáctor de Potencia >0.97
THD <0,8%
Altura de montaje Min 2,5mt Máx 18mt
Posición de uso Universal / Horizontal
Ip 66

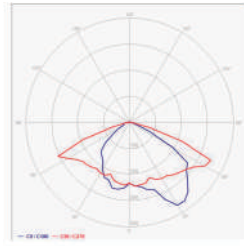
Diagrama de distribución



FINALIDAD DEL PRODUCTO







-  Exterior
-  Iluminación de áreas calles y autopistas
-  Fijación a poste, par de apriete 8 NM

Driver



Corriente Constante
F.P. >0.97
THD ≤0,8
Frecuencia 50/60Hz

CARACTERÍSTICAS FÍSICAS

-  Gran distribución luminosa
-  Carcasa hermética IP66.
-  Ambiente de funcionamiento: temperatura entre -30°C a +70°C y humedad 10% a 95%.
-  Producto certificado según PE N° PE5/07
-  Pintura electrostática.
-  Accesorios de acero inoxidable y galvanizados en caliente

Medidas

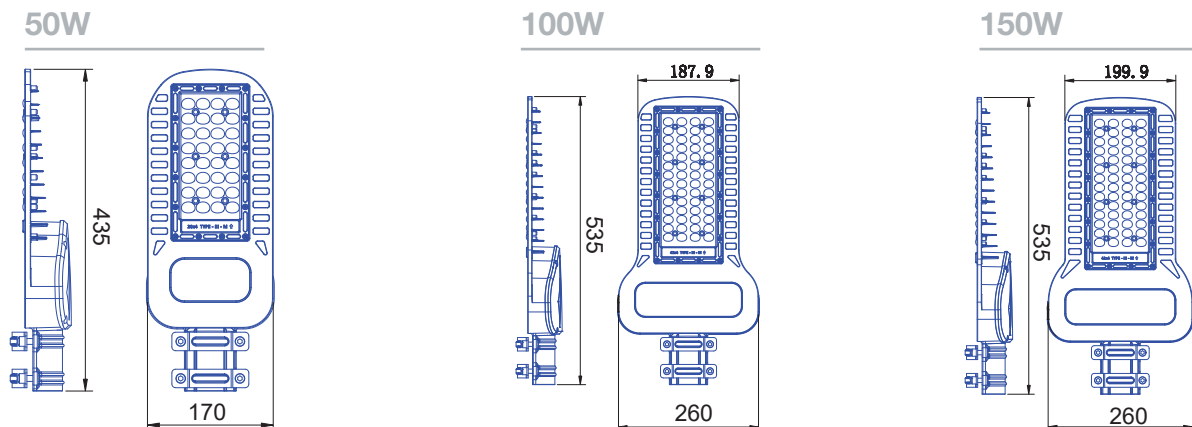

Modelo	Potencia (W)	Dimensiones (mm)	Peso (Kg)	Voltaje de entrada (Vac)	Frecuencia (Hz)	Código	Corriente (A)
MONZON	50	435x170x63	1,6	90-305V	50 / 60Hz	20900050	0,22A
MONZON	100	535x260x64	2,4	90-305V	50 / 60Hz	20900100	0,47A
MONZON	150	535x260x64	2,8	90-305V	50 / 60Hz	20900150	0,68A

